

MKDSP 25/ 5-15,00-F

Order No.: 1932520

The figure shows a 5-pos. version of the product

<http://eshop.phoenixcontact.de/phoenix/treeViewClick.do?UID=1932520>

PCB terminal block with mounting flange, nominal current: 125 A,
rated voltage: 1000 V, pitch: 15.0 mm, no. of positions: 5, mounting:
Soldering, type of connection: Screw connection, connection direction
from the conductor to the PCB: 0°

Commercial data

EAN	4017918902216
Pack	25 Pcs.
Customs tariff	85369010
Weight/Piece	0.107216 KG
Catalog page information	Page 295 (CC-2007)

Product notes

WEEE/RoHS-compliant since:
12/20/2005

<http://www.download.phoenixcontact.com>
Please note that the data given here has been taken from the online catalog. For comprehensive information and data, please refer to the user documentation. The General Terms and Conditions of Use apply to Internet downloads.

Technical data

Dimensions / positions

Pitch	15 mm
Dimension a	60 mm
Number of positions	5

Pin dimensions	1,2 x 1,2 mm
Hole diameter	1.6 mm
Screw thread	M5
Tightening torque, min	2.5 Nm

Technical data

Insulating material group	I
Rated voltage (III/2)	1000 V
Rated voltage (II/2)	1000 V
Connection in acc. with standard	EN-VDE
Nominal current I_N	125 A
Nominal voltage U_N	1000 V
Nominal cross section	35 mm ²
Maximum load current	125 A (with 35 mm ² conductor cross section)
Insulating material	PA
Inflammability class acc. to UL 94	V0
Internal cylindrical gage	B7
Stripping length	18 mm

Connection data

Conductor cross section solid min.	0.5 mm ²
Conductor cross section solid max.	35 mm ²
Conductor cross section stranded min.	0.5 mm ²
Conductor cross section stranded max.	25 mm ²
Conductor cross section stranded, with ferrule without plastic sleeve min.	1 mm ²
Conductor cross section stranded, with ferrule without plastic sleeve max.	25 mm ²
Conductor cross section stranded, with ferrule with plastic sleeve min.	1.5 mm ²
Conductor cross section stranded, with ferrule with plastic sleeve max.	25 mm ²
Conductor cross section AWG/kcmil min.	20
Conductor cross section AWG/kcmil max	2
2 conductors with same cross section, solid min.	0.5 mm ²
2 conductors with same cross section, solid max.	6 mm ²

2 conductors with same cross section, stranded min.	0.5 mm ²
2 conductors with same cross section, stranded max.	6 mm ²
2 conductors with same cross section, stranded, ferrules without plastic sleeve, min.	0.5 mm ²
2 conductors with same cross section, stranded, ferrules without plastic sleeve, max.	4 mm ²
2 conductors with same cross section, stranded, TWIN ferrules with plastic sleeve, min.	0.5 mm ²
2 conductors with same cross section, stranded, TWIN ferrules with plastic sleeve, max.	6 mm ²

Certificates / Approvals



CUL

Nominal voltage U _N	600 V
Nominal current I _N	115 A
AWG/kcmil	20-2

UL

Nominal voltage U _N	600 V
Nominal current I _N	115 A
AWG/kcmil	20-2
Certification	CB, CCA, CUL, GOST, SEV, UL

Accessories

Item	Designation	Description
Marking		
0811192	SK 15/5:UNBEDRUCKT	Marker card, unprinted, with 12 pcs., 10-section marker strips, self-adhesive, color: White
0811202	ZBF 15:UNBEDRUCKT	Zack strip, flat, unprinted, 5-section, divisible, for labeling by the customer
Plug/Adapter		
0201647	RPS	Reducing plug, for transition from 4 mm diameter test plug socket, insulation: gray

Tools

1205079	SZS 1,0X6,5	Screwdriver, bladed, matches all screw terminal blocks with a connection cross section of over 16 mm ² , blade: 1.0 x 6.5 mm
---------	-------------	---

Drawings

Drilling diagram

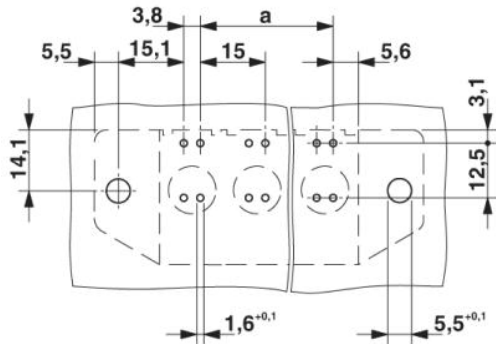

Dimensioned drawing

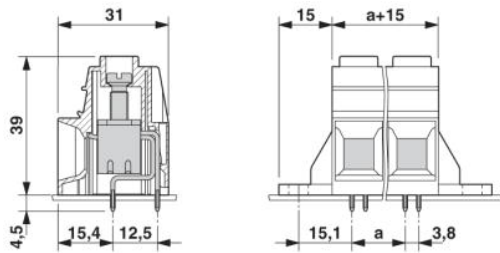

Address

PHOENIX CONTACT Inc., USA
586 Fulling Mill Road
Middletown, PA 17057, USA
Phone (800) 888-7388
Fax (717) 944-1625
<http://www.phoenixcon.com>



© 2008 Phoenix Contact
Technical modifications reserved;